

REV No.	REVISION NOTE	DATE

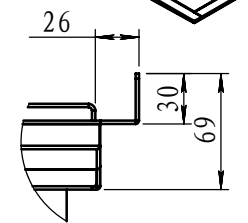

DETAIL A  
DETAIL 2 : 9

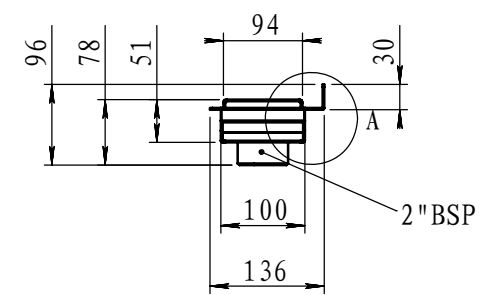
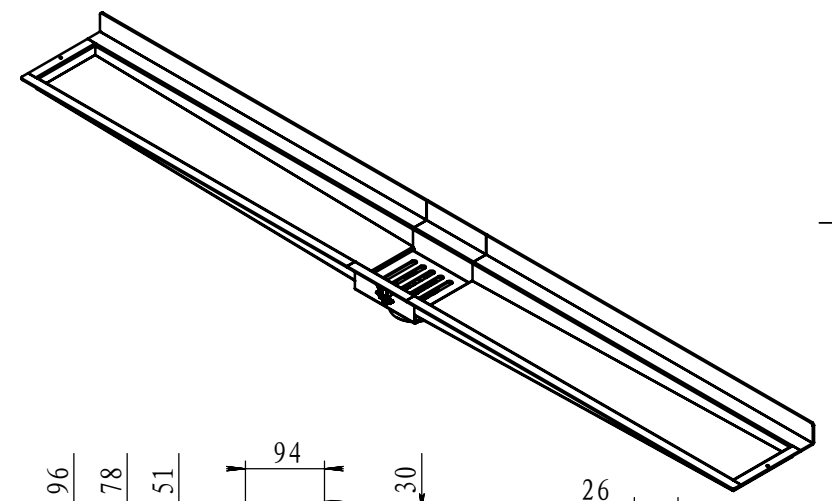
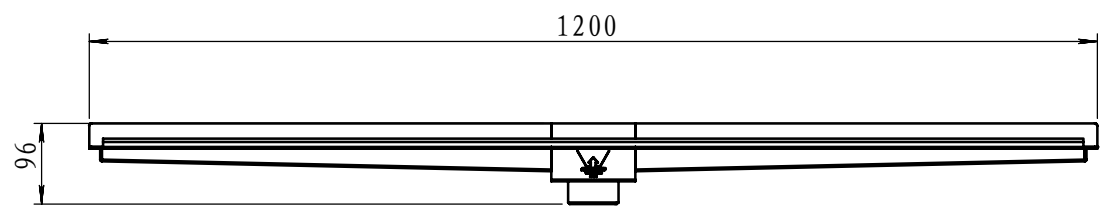
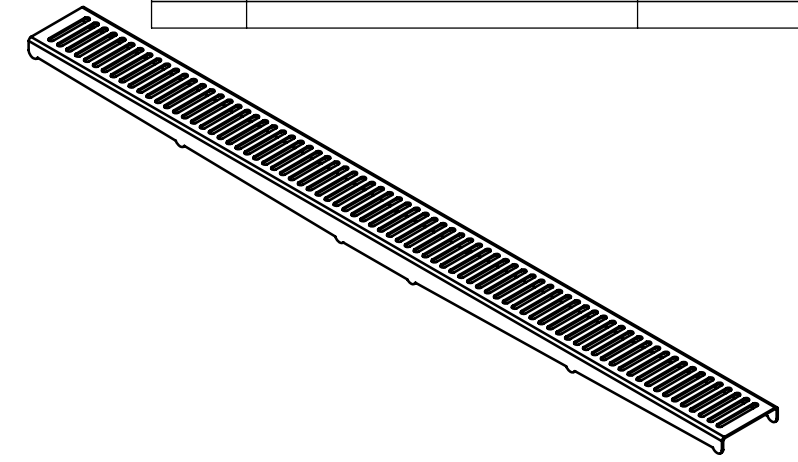
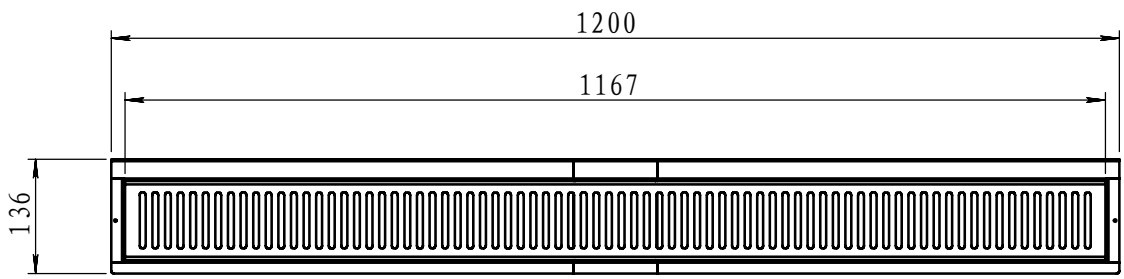
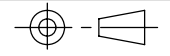

TOLERANCES TYP.  
LINEAR +/- 0.5mm  
ANGULAR +/- 0.5°  
ALL DIMENSIONS IN MILLIMETRES  
UNLESS NOTED OTHERWISE.  
DO NOT SCALE FOR CONSTRUCTION  
PURPOSES.



11 LUDLA CRESCENT DANDENONG SOUTH, VIC3175  
Tel: (03) 9768 3577 Fax: (03) 9768 3466  
Web: www.lanark.com.au

DESIGNED LUCKY	DATE 2010-11-1
DRAWN LUCKY	SHEET SIZE A4
CHECKED JINF	SCALE 1:9

SHOWER CHANNEL 1200 DB				
		PROJECT No.	SHEET No.	REVISION
SC-1200-DB-01		1 OF 1		